



川源(中国)机械有限公司  
GSD (China) Co., Ltd.



# DWS

## 陆上型高效排污泵

**DWS**  
**Land based high-efficiency sewage pump**

# DWS 陆上型高效排污泵

## DWS Land based high-efficiency sewage pump



### 特点

- 干井式结构易于安装维护保养。
- 叶轮为不堵塞型结构，可使污物轻易通过，使流道不致堵塞，组装前均经过动平衡校正。
- 泵体DN250(含)以上设有清除异物之除污盖，无须拆卸泵浦即可轻易清除异物及污泥，便于定时保养，减少故障的机率。
- 使用全封闭滚珠轴承，可承受泵浦工作时所产生之轴向推力。
- 采用机械密封，机械密封材质为SiC-SiC。

### Features

- Dry pit construction is easily installed and maintained.
- Impeller is non-clog type, it makes sludge and sewage free to pass the flow passages. The impeller is dynamically balanced before assembly the pump.
- Pump DN250 and above have handholecover to clear the foreign objects. We can easily clear Foreign body and sludge without disassemble the other components, It is convient to be cared and maintained, and can prevent pump from being out of order.
- Full closed ball bearings are added protection for high loads.
- Shaft seal is mechanical seal. The material of mechanical seal is SiC.

### 用途

- 污水处理厂污泥及污物抽送。
- 生活废水及工厂污水抽送。

### Application

- Wastewater treatment plant sewage and sludge pumping equipment.
- Municipal and industrial wastewater pumping equipment.

### 型号说明 Type description



## 结构简图 Construction

DWS

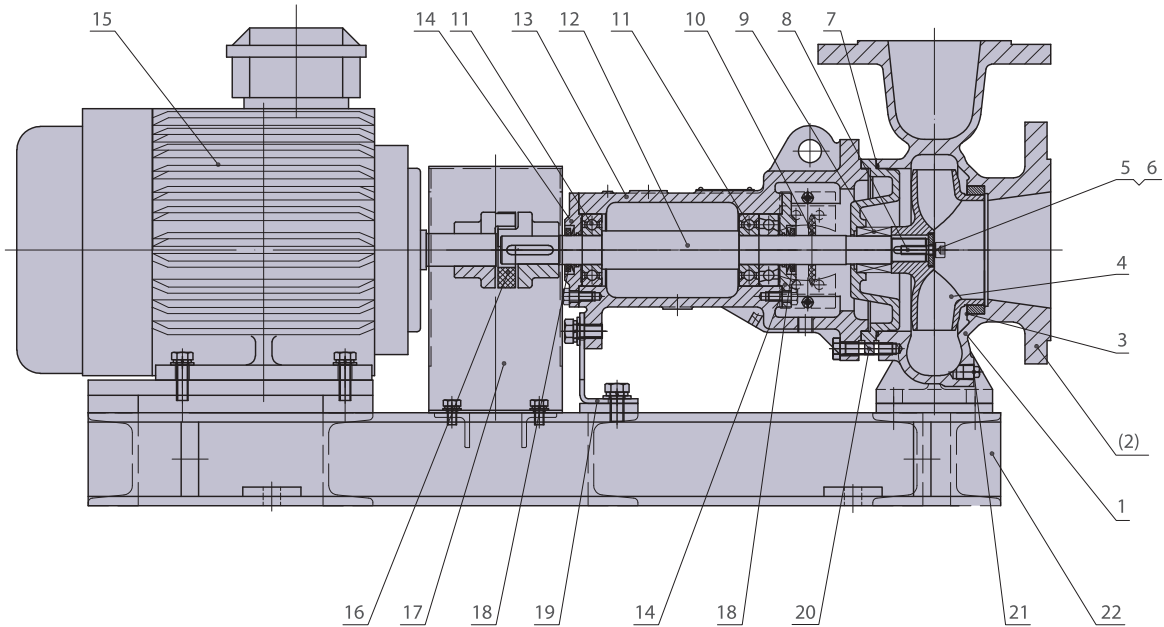

序号 NO.	名称 Name	材质 Material	材质	
			HT	304
1	泵体	Pump casing	HT250	ZG07Cr19Ni10
(2)	前盖	Front cover	HT250	ZG07Cr19Ni10
3	密封环	Seal ring	ZCuSn10Pb5	-
4	叶轮	Impeller	HT200	ZG07Cr19Ni10
5	螺栓	Bolt	06Cr19Ni10	06Cr19Ni10
6	叶轮垫圈	Impeller Washer	20Cr13	06Cr19Ni10
7	O型圈	O-ring	NBR	VITON
8	键	Key	20Cr13	06Cr19Ni10
9	机械密封	Mechanical seal	SiC-SiC-NBR	SiC-SiC-VITON
10	挡水圈	Water baffling ring	NBR	NBR
11	轴承	Bearing	-	-
12	主轴	Shaft	20Cr13	06Cr19Ni10
13	轴承体	Bearing body	HT250	HT250
14	轴承盖	Bearing cover	HT250	HT250
15	电机	Motor	-	-
16	联轴器	Coupling	45	45
17	联轴器护罩	Coupling housing	Q235A	Q235A
18	VD密封圈	VD seal ring	VITON	VITON
19	轴承体支架	Bearing stand	Q235A	Q235A
20	后盖	Back cover	HT250	ZG07Cr19Ni10
21	丝堵	Plug	Q235A	06Cr19Ni10
22	机座	Base	Q235A	Q235A



型谱图 Performance chart

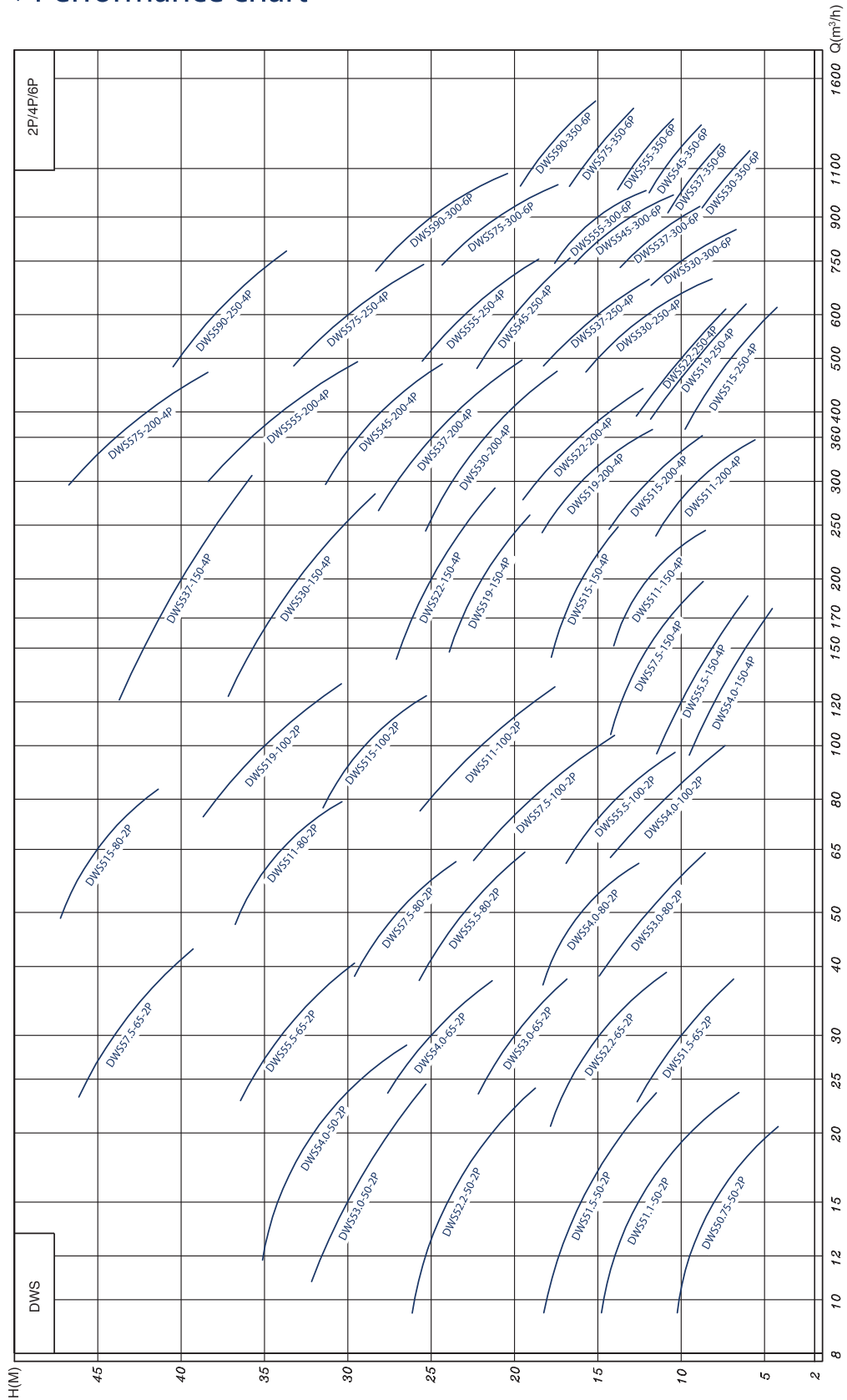

## 性能参数 Performance parameters

(2P/4P/6P)

泵型号 Pump model	转速 Speed (r/min)	流量 Capacity (m <sup>3</sup> /h)	扬程 Head (m)	效率 Eff. $\eta$ (%)	电机功率 Motor power (kW)	口径 Dia. (mm)	重量 Weight (kg)
DWS50.75-50-2P	2840	15	8	58	0.75	50	73
DWS51.1-50-2P	2840	15	12.5	60	1.1	50	75
DWS51.5-50-2P	2840	15	16	55	1.5	50	90
DWS52.2-50-2P	2840	15	24	54	2.2	50	93
DWS53.0-50-2P	2840	15	30	54	3.0	50	105
DWS54.0-50-2P	2840	20	32	56	4.0	50	115
DWS51.5-65-2P	2840	30	10	62	1.5	65	87
DWS52.2-65-2P	2840	30	15	64	2.2	65	90
DWS53.0-65-2P	2840	30	20	60	3.0	65	105
DWS54.0-65-2P	2840	30	25	62	4.0	65	115
DWS55.5-65-2P	2840	30	34	58	5.5	65	160
DWS57.5-65-2P	2840	30	44	58	7.5	65	165
DWS53.0-80-2P	2840	50	12	65	3.0	80	102
DWS54.0-80-2P	2840	50	16	67	4.0	80	112
DWS55.5-80-2P	2840	50	23	63	5.5	80	155
DWS57.5-80-2P	2840	50	27	66	7.5	80	160
DWS511-80-2P	2840	65	34	65	11	80	210
DWS515-80-2P	2840	65	45	66	15	80	215
DWS54.0-100-2P	2840	80	11	67	4.0	100	142
DWS55.5-100-2P	2840	80	14	68	5.5	100	157
DWS57.5-100-2P	2840	80	19	69	7.5	100	160



## 性能参数 Performance parameters

(2P/4P/6P)

泵型号 Pump model	转速 Speed (r/min)	流量 Capacity (m <sup>3</sup> /h)	扬程 Head (m)	效率 Eff. $\eta$ (%)	电机功率 Motor power (kW)	口径 Dia. (mm)	重量 Weight (kg)
DWS511-100-2P	2840	100	22	66	11	100	228
DWS515-100-2P	2840	100	29	67	15	100	235
DWS519-100-2P	2840	100	35	68	18.5	100	250
DWS54.0-150-4P	1450	120	8	72	4.0	150	176
DWS55.5-150-4P	1450	120	10	73	5.5	150	195
DWS57.5-150-4P	1450	150	12	74	7.5	150	209
DWS511-150-4P	1450	200	12	70	11	150	325
DWS515-150-4P	1450	200	16	70	15	150	340
DWS519-150-4P	1450	200	22	74	18.5	150	375
DWS522-150-4P	1450	200	25	70	22	150	386
DWS530-150-4P	1450	200	33	71	30	150	565
DWS537-150-4P	1450	200	40	72	37	150	600
DWS511-200-4P	1450	300	9	73	11	200	352
DWS515-200-4P	1450	300	12	74	15	200	370
DWS519-200-4P	1450	300	16	76	18.5	200	405
DWS522-200-4P	1450	360	16	75	22	200	416
DWS530-200-4P	1450	360	22	76	30	200	590
DWS537-200-4P	1450	360	25	77	37	200	625
DWS545-200-4P	1450	400	28	74	45	200	850
DWS555-200-4P	1450	400	34	75	55	200	1000
DWS575-200-4P	1450	400	42	76	75	200	1130



## 性能参数 Performance parameters









(2P/4P/6P)

泵型号 Pump model	转速 Speed (r/min)	流量 Capacity (m <sup>3</sup> /h)	扬程 Head (m)	效率 Eff. $\eta$ (%)	电机功率 Motor power (kW)	口径 Dia. (mm)	重量 Weight (kg)
DWS515-250-4P	1450	500	7	74	15	250	440
DWS519-250-4P	1450	500	9	74	18.5	250	480
DWS522-250-4P	1450	500	10	75	22	250	490
DWS530-250-4P	1450	600	12	76	30	250	625
DWS537-250-4P	1450	600	15	77	37	250	655
DWS545-250-4P	1450	600	20	78	45	250	685
DWS555-250-4P	1450	600	23	75	55	250	950
DWS575-250-4P	1450	600	30	76	75	250	1110
DWS590-250-4P	1450	600	38	78	90	250	1180
DWS530-300-6P	980	750	10	75	30	300	1030
DWS537-300-6P	980	900	10	76	37	300	1110
DWS545-300-6P	980	900	13	77	45	300	1185
DWS555-300-6P	980	900	15	76	55	300	1300
DWS575-300-6P	980	900	21	77	75	300	1750
DWS590-300-6P	980	900	25	79	90	300	1900
DWS530-350-6P	980	1000	8	79	30	350	1050
DWS537-350-6P	980	1000	10	81	37	350	1130
DWS545-350-6P	980	1100	11	83	45	350	1200
DWS555-350-6P	980	1100	13	77	55	350	1300
DWS575-350-6P	980	1200	15	78	75	350	2100
DWS590-350-6P	980	1200	18	79	90	350	2180



欢迎索取以下产品型录

To find out more about following products, please visit [www.gsd.net.cn](http://www.gsd.net.cn)

	<b>泵系列</b> Pump Series	潜水泵系列   陆上泵系列   特种泵系列 Submersible pump series   On land pump series   Special pump series
	<b>搅拌推流系列</b> Mixing and flow propeller	搅拌机系列   推流器系列 Mixing series   Flow propeller series
	<b>供氧曝气系列</b> Aeration equipment series	曝气机系列   曝气盘系列   曝气管系列 Aerator series   Disc diffusers   Tube diffusers
	<b>风机系列</b> Blower Series	磁悬浮鼓风机   空气悬浮鼓风机   三叶罗茨鼓风机系列 Maglev turbo blower   Turbo blower   Three-lobe roots blower series
	<b>污泥处理设备</b> Sludge treatment equipment	带式脱水机   厢式压滤机   叠螺式脱水机   污泥干化设备   浅层高效气浮设备 Belt filter press   Box filter press   Screw press   Mud scraper   Dissolved air flotation clarifier
	<b>智能化系列</b> Intelligent series	智能设备   水务设备健康管理   水务系统工艺优化智联管理 Intelligent equipment   Health management for water equipment   Intelligent management for water system process
	<b>反应器及套装设备</b> Reactor and package equipment	芬顿反应系统   MBR生物膜反应器   预制泵站   一体化污水处理设备 Fenton reaction system   MBR biofilm reactor   Prefabricated pumping station   Intelligent Compact Unit
	<b>耗材药剂及相关设备</b> Consumables, reagents and related equipment	生物绳   PAC 聚合氯化铝   PAM 聚丙烯酰胺   泡药设备 Biological rope   PAC polyaluminum chloride   PAM polyacrylamide   Automatic dispensing dissolvers

GSD 的经营理念 Business Philosophy

G-Green 绿色 S-Safe 安全 D-Development 永续经营



川源(中国)机械有限公司  
GSD (China) Co., Ltd.

水处理系统专业合作伙伴

Professional partners in water treatment systems

免费咨询电话

400-657-9066

川源(中国)机械有限公司版权所有 all rights reserved. CY-41

数据来源: 公司实验室数据及客户实际使用数据, 具体使用环境不同, 数据可能存在差异。本型录内容如有变更, 恕不另行通知。

The data on the brochure is based on the laboratory testing data and customers' actual operation data in the past. The actual data may be different in different application conditions. We reserve the right to change content without notice.

