

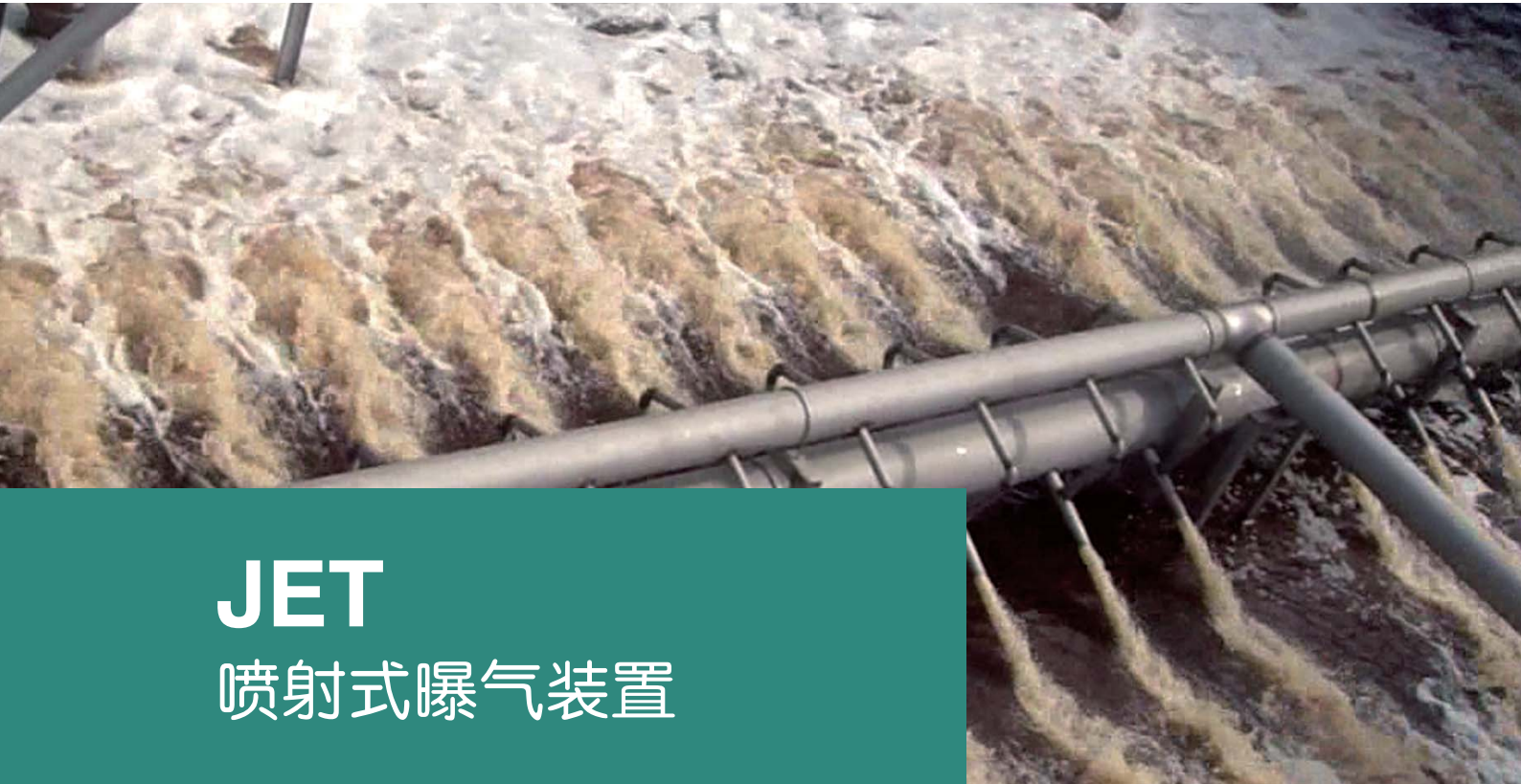

川源（中国）机械有限公司
GSD Industrial Co.,Ltd.



JET

喷射式曝气装置

JET aeration system

JET 喷射式曝气装置

JET aeration system

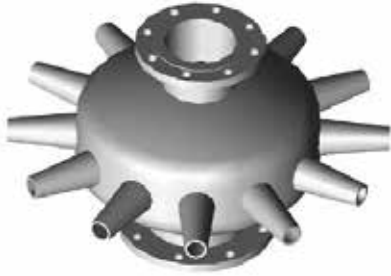

简介

现今废水处理的方法中，生物处理被广泛应用。生物处理主要分为好氧及厌氧两大类。但就普及性、方便性及稳定性而言，好氧处理占有率高达80%以上。好氧处理最主要之关键在于如何充分有效地将空气中之氧气输入水中，供给微生物分解污染物质，以及如何产生良好且完全混合之搅拌，以避免生物污泥之沉淀累积。由此可知，曝气设备的选择，在生物处理领域中起着成败攸关的作用。有鉴于此，本公司致力生产高效率且适合各种不同水深(使用实绩最高水深达15m)之喷射式曝气设备。

General

Aeration is often considered to be the heart of the effluent treatment system at most wastewater treatment plants. The correct selection of an aeration system is crucial because the operation of the aeration system requires about 80% of the total operating power cost for a wastewater treatment plant. In addition, during periods of low service demands, air flow rates can be reduced by controlling and varying the blower output. By regulating the air flowing to the aeration system, oxygen transfer rates can be controlled without affecting the mixing efficiency or solids suspension and additional energy savings are achieved. Practical for very deep tanks that the deep is 15m in Taiwan.

特性

整个系统主要由喷射式曝气机、循环水泵及鼓风机所组成。该曝气装置将由循环水泵所输送之液体，经由液体管、内喷嘴到喷嘴混合室与由空气管所压送之空气混合均匀后，呈喷射流经外喷嘴水平射出。为达循环水与空气之均匀供应与混合，以提高曝气机之效率，故特别设计液体管与空气管分开，且每一空气支管单独与每一组喷嘴配合连接。喷射式曝气装置喷嘴之作用原理如下图：

Characteristics

JET aeration system consists of jet aerator, recirculation pump and blower. JET aeration system pumps the fluid into aerator through inner nozzle. At the same time, JET aeration system blows air into aerator through outer nozzle. For well mixed, JET aeration system has a special design, buffer zone in which air and fluid will be mixed completely. Please see the figure below.

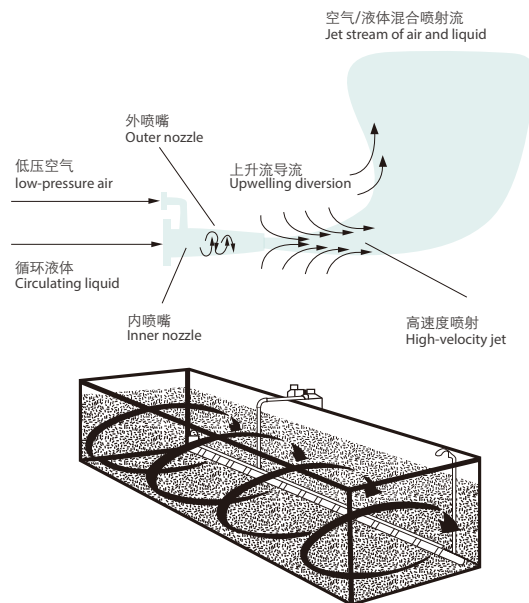

用途

适用于调匀池及任何好氧性之生物处理系统，如各种活性污泥法，氧化沟、氧化塘或SBR。且可控制空气量之多寡做脱氮、硝化等处理程序。

特点

- 高传氧效率。
- 除沉水式循环水泵外，水中无运转配件。
- 适用于变动的水位。
- 低动力消耗。
- 可分开控制氧量之传输及搅拌。
- 使用于深层曝气及高MLSS之场合，相对于其它曝气系统所需之反应池容积较小，节省空间。
- 抗腐蚀之配件。
- 系统简单，故安装费用低。
- 可使用自清式反冲洗系统，以克服异物阻塞时停机须泄清池水之困扰。
- 沉水式设计，能防止热能散失，无冰冻之顾虑，于各季节均能维持生物活动力。

Applications

JET aeration system will be utilized in equalization tank and aeration system. For example, activated sludge process, oxidation ditch, aerated lagoon and SBR. JET aeration system would be also utilized in denitrification & nitrification, if air flow will be controlled.

Features

- High oxygen transfer efficiency.
- No moving parts in the water except recirculation pump.
- Apply to the fluctuant water level.
- Low power consumption.
- Oxygen transmission and mixing can be controlled separately.
- Apply to deep aeration and high MLSS situation. Saving more space compared with other aerating systems.
- Corrosion resistant parts.
- Simple system, low-cost for installation.
- When the machine is blocked, to avoid stopping and emptying pool, the self-cleaning backwashing system could be used.
- Submersible design can prevent heatloss, no frozen, micro organism can keep their activity in every season.

型号说明 Type description



喷嘴规格表 Nozzle specification

型号说明	Model description	JET50	JET65	JET80
外喷嘴口径	Outer nozzle diameter (mm)	50	65	80
喷嘴数量	Nozzle quantity	8 - 12	12 - 16	16 - 24
单个喷嘴液体流量	Fluid flow of each nozzle (m ³ /min)	0.34 - 0.40	0.75	1.50
单个喷嘴空气流量	Air flow of each nozzle (m ³ /min)	0.28 - 0.85	0.56 - 1.69	1.13 - 3.39



溶氧效率曲线 OTE curve

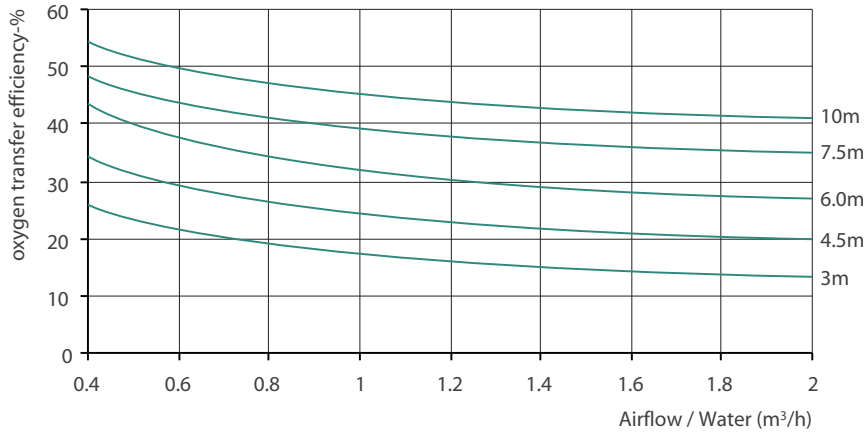

曝气作用区: 气水比 < 1 Zone of aeration: gas water ratio < 1
 搅拌作用区: 气水比 > 1 Zone of mixing: gas water ratio > 1

安装示意图 Installation Instruction

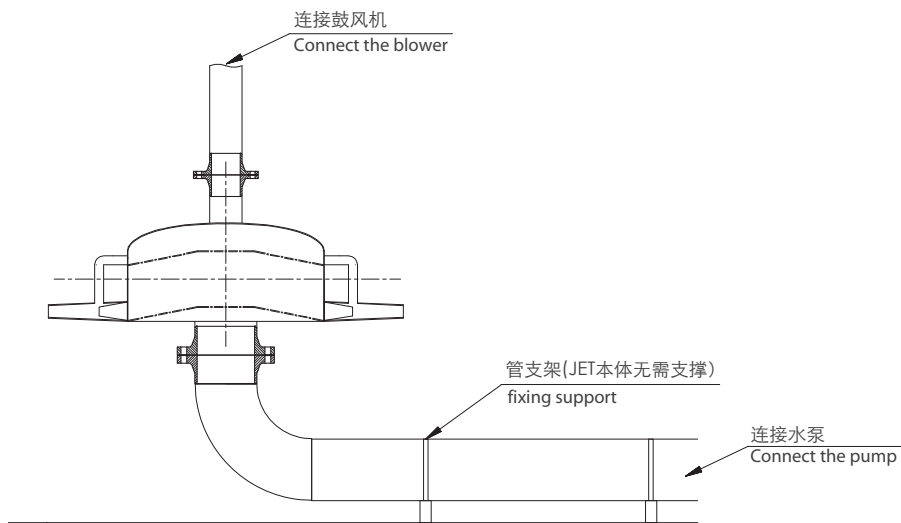

结构简图及材质 Construction and material

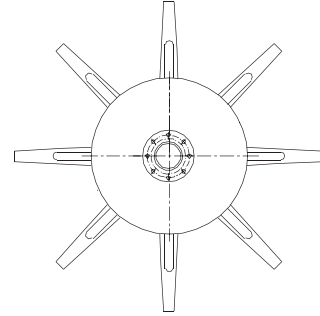
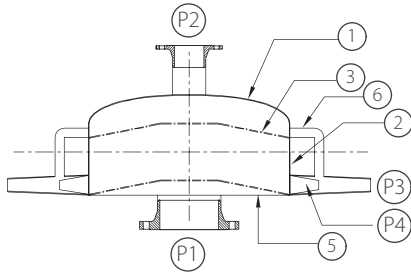

JET-X

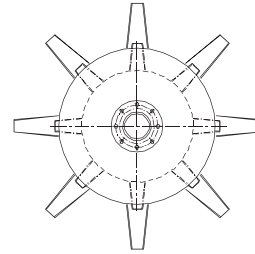
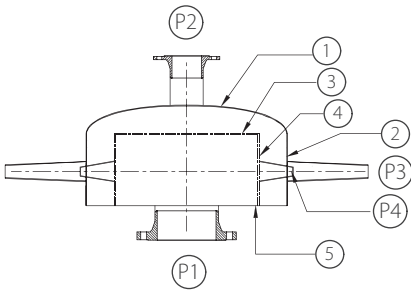









JET-A

No.	名称	Name	材质	Material
P1	入水口	Water inlet	SUS304	
P2	进气口	Air intake	SUS304	
P3	外喷嘴	Outer nozzle	SUS304	
P4	内喷嘴	Inner nozzle	SUS304	
1	外端板	External end cover	SUS304	
2	外桶身	External body	SUS304	
3	内端板	Internal end cover	SUS304	
4	内桶身	Internal body	SUS304	
5	底板	Base plate	SUS304	
6	气管支管	Air manifold	SUS304	



欢迎索取以下产品型录

	泵系列	潜水泵系列 陆上泵系列 特种泵系列
	搅拌推流系列	搅拌机系列 推流器系列
	供氧曝气系列	曝气机系列 曝气盘系列 曝气管系列
	风机系列	三叶罗茨鼓风机系列 增压罗茨鼓风机系列 沉水式风机系列 空气悬浮离心鼓风机
	污泥处理设备	带式脱水机 厢式压滤机 非金属矩形刮泥机 浅层高效气浮设备
	智能化系列	EP6 物联监控管理系统 空气质量管理系统 RS-485 传感器
	反应器及套装设备	芬顿反应系统 MBR生物膜反应器 预制泵站 一体化污水处理设备
	耗材药剂及相关设备	生物绳 PAC 聚合氯化铝 PAM 聚丙烯酰胺 泡药设备



环保设备和技术服务的专业伙伴

免费咨询电话

400-657-9066

本型录内容如有变更，恕不另行通知。
We reserve the right to change content without notice.

川源(中国)机械有限公司版权所有 all rights reserved. CY-K9

